

Inline Deflagration Flame Arrester

: 1003-0021-70

EC design test certificate no.

: IBExU 14 ATEX 2024 X

Standard gap (MESG)

: $\geq 0,50$ mm

Explosion group

: Ex G IIB

Operating direction

: Bidirektional / Bi-directional

Flange connection

: EN1092-1 Typ01 (DIN2576) PN10(16)

Weight

: ~ 16,7 kg

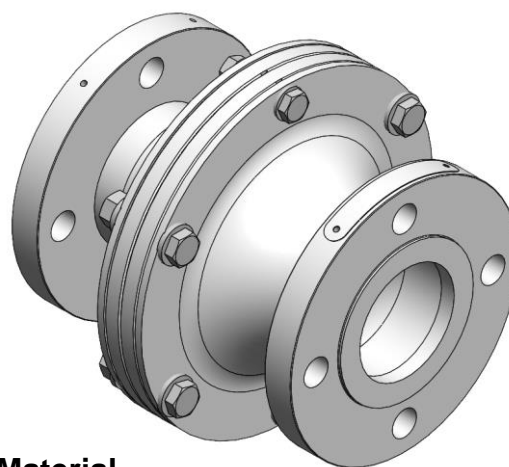
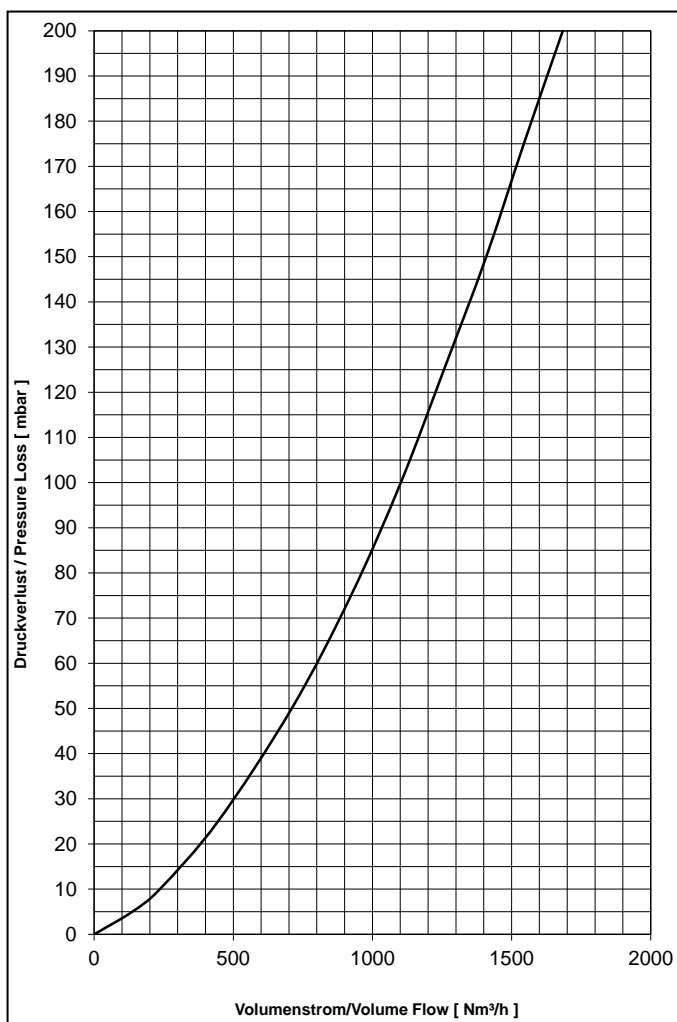

Material

Housing

V4A/AISI 316 range

Flame Arrester Element

1.4571 / AISI 316 Ti

O-Ring

PTFE

Operating Data

Type : DEF

Absolute pressure : $\leq 1,2$ bar

Temperature : $\leq 60,0$ °C

Nominal pipe size : \leq DN80

Pressure loss

Medium Air

$p_0 = 1013$ mbar, $T_0 = 273$ K, density = $1,293$ kg/m³